

YAMAHA RX-500/U

Natural Sound Stereo Receiver

Ampli-tuner stéréo de la série "Natural Sound"

Natural Sound Stereo-Receiver

Natural Sound Stereo Receiver

Ricevitore Stereo a Suono Naturale

OWNER'S MANUAL

MANUEL D'UTILISATION

BEDIENUNGSANLEITUNG

BRUKSANVISNING

MANUALE DELL'UTENTE

Thank you for purchasing the YAMAHA RX-500/U. In order to ensure proper operation for the best possible performance, please read this manual thoroughly before connecting up your new receiver and turning it on.

IMPORTANT!

Please record the serial number of your unit in the space below.

Model: RX-500/U

Serial No:

PRECAUTIONS

OWNER'S MANUAL

Keep this manual in a safe place for future reference.

LOCATION

Avoid placing your RX-500/U in direct sunlight or close to a source of heat. Also avoid locations in which the device is likely to be subjected to excessive dust, cold or moisture.

VENTILATION

The openings on the cabinet ensure the ventilation of the receiver. If these openings are obstructed, the temperature inside the cabinet will rise rapidly and eventually damage the circuits. Therefore, avoid placing objects against these openings and do not install your receiver in a place where the flow of air through the ventilation openings could be impeded.

HANDLING

● Power cord

When removing the power plug from the wall outlet, always pull directly on the plug. Never yank the cord as this may result in damage to the cord and possibly a short-circuit.

If you do not intend to use this unit for an extended period of time, it is advisable to unplug the power cord.

● Switches and knobs

Avoid applying excessive force to the switches and knobs.

● Relocation

Before moving your receiver, be sure to unplug the power cord and remove all other connecting cables.

IN CASE OF TROUBLE

● Troubleshooting Chart

Consult the Troubleshooting Chart for advice on common operating errors before concluding that your receiver is faulty.

● Servicing

Do not open the cabinet or attempt to make repairs by yourself as this may aggravate the damage and expose you to an electrical shock. For any servicing, refer to your YAMAHA dealer.

● Object and liquid entry

See to it that foreign objects or spilled liquids do not enter into the cabinet. Should this case arise, consult your YAMAHA dealer.

CLEANING

Wipe off dust with a dry soft cloth. To remove dirt or fingermarks, use a damp cloth then dry immediately with a clean cloth. Do not use alcohol, thinners or other chemical solvents since they may damage the finish or remove the panel lettering.

Do not use any aerosol sprays near this unit as these products can easily get into the unit and damage the circuitry.

● Back-Up Power

The back-up power supply will keep the preset stations memorized for one week if the power supply fails or the set is unplugged. In order to keep the back-up power supply fully charged when the set is not in use, turn the power on once a week.

To ensure proper memory setting when first programming the preset stations, the receiver should remain ON for one hour.

SPECIAL INSTRUCTIONS FOR THE BRITISH MODEL

THE WIRES IN THE MAINS LEAD ARE COLOURED IN ACCORDANCE WITH THE FOLLOWING CODE:

Blue: NEUTRAL

Brown: LIVE

As the colours of the wires in the mains lead of this apparatus may not correspond with the coloured markings identifying the terminals in your plug, proceed as follows:

The wire which is coloured BLUE must be connected to the terminal which is marked with the letter N or coloured BLACK. The wire which is coloured BROWN must be connected to the terminal which is marked with the letter L or coloured RED.

VOLTAGE SELECTOR (General Model)

The voltage selector switch on the rear panel of the RX-500/U must be set for your local voltage BEFORE plugging in the AC mains supply. Voltages are 110/120/220/240 V AC, 50/60 Hz.

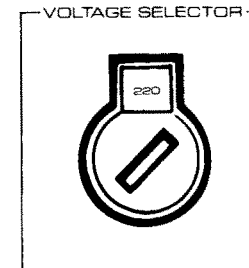

RX-500/U

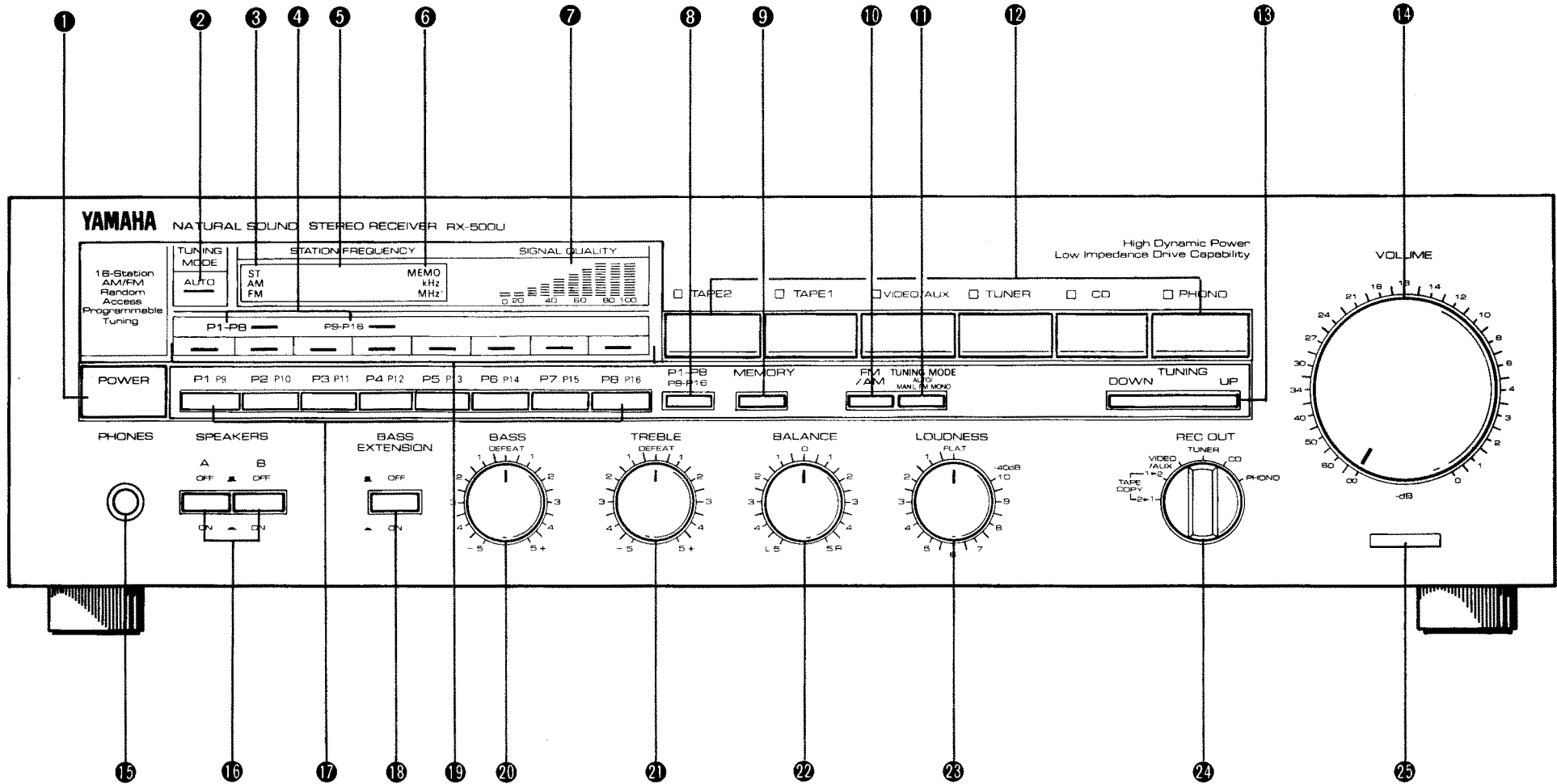

FRONT PANEL DESCRIPTIONS

The Front Panel illustration is provided on page 5.

1 POWER SWITCH

Press once to turn power on and again to turn power off.

2 TUNING MODE INDICATOR

The AUTO indicator lights when the TUNING MODE key is set to AUTO and remains off when set to MANUAL.

3 "ST" INDICATOR

Lights when an FM stereo broadcast with a sufficient signal strength is received.

4 P1-8/P9-16 RANGE INDICATORS

Light to indicate which range is engaged.

5 FREQUENCY DISPLAY

A digital display of the frequency recalled by the PRESET keys or tuned in by the TUNING key.

6 MEMORY INDICATOR

Pressing the MEMORY key causes this indicator to flicker for a period of approx. 5 seconds, during which, memory presetting may be performed.

7 SIGNAL QUALITY INDICATOR

This indicator shows the reception strength of the currently tuned station. When tuning in a station, adjust the antenna height and orientation for maximum signal quality.

8 P1-8/P9-16 SELECTOR

This selector performs switching between the 1-8 and 9-16 ranges. Allowing for memory programming and pre-set selection of up to 16 stations.

9 MEMORY BUTTON

Press this key to store a station in the programmable memory. When pressed, the Memory Indicator will flicker for approx. 5 seconds. While the indicator is flickering press one of the Preset keys to store the currently displayed frequency into the memory.

10 BAND SELECTOR

This selects either AM or FM broadcasts.

11 TUNING MODE KEY

Press once to set to Auto and again to set to manual. Auto sets the tuner in the auto-search mode. Pressing the Tuning key automatically tunes in the first station in the direction selected. FM Muting is active in this mode. Manual/FM Mono sets the tuner in the manual tuning mode, where FM Muting is inactive, allowing extremely weak stations to be received. In this mode even stereo broadcasts will be received in mono. This will improve the reception quality of weak, noisy stereo broadcasts.

12 INPUT SELECTOR PANEL

Selects the desired input source. The indicator LED above the selected source will light up.

13 TUNING KEY

When the Tuning Mode has been set to AUTO, pressing the DOWN half of the key scans the frequency band downwards until a station is encountered, automatically tuning in the station (Auto-search Tuning). Pushing the key again scans progressively lower frequencies until the next station is found. When the bottom of the band is reached, the frequency is set to the top of the band and the scan continues downward. Pressing the UP half of the key performs this by scanning the band upwards. When the Tuning Mode has been set to MANUAL, pressing the key scans UP or DOWN the band only as long as the key is held. Pressing the Tuning key briefly advances the scan in steps of 100kHz for FM or 10kHz for AM. (The General model is provided with a Frequency Step switch which enables the switching between 100kHz FM/10kHz AM and 50kHz FM/9kHz AM.)

14 VOLUME CONTROL

This controls the sound level. Turning clockwise increases the sound volume while turning counterclockwise decreases it. Set this knob to the minimum level before turning the power on or using the Input Selector Panel to select a different sound source, therefore protecting speakers from any sudden high level sound.

15 HEADPHONES JACK

Stereo headphones with a standard plug can be connected to this jack. Speaker switches A and B should be set to the OFF position when listening to the headphones only.

16 SPEAKERS SWITCHES

As one or two speaker systems can be connected to the RX-500/U these switches allow you to select speaker system A, B or both. When listening to headphones only press both the A and B switches to the OFF position.

17 PRESET STATION KEYS

Use these keys, together with the P1-8/P9-16 Selector, to recall an AM/FM station or to store a station in the memory. Any random selection of AM or FM stations can be programmed using these keys.

18 BASS EXTENSION BUTTON

Pressing this button boosts bass response while maintaining overall tonal balance. This is useful to compensate for speakers with weak bass or a listening environment that deadens the bass.

19 PRESET STATION INDICATORS

Light to indicate which preset station is currently selected.

20 BASS CONTROL

This knob controls bass response. Turn it clockwise to boost or counterclockwise to attenuate bass response. When this knob is set to the center defeat position a flat response is obtained.

21 TREBLE CONTROL

This knob controls treble response. Turn it clockwise to boost or counterclockwise to attenuate treble response. When this knob is set to the center defeat position a flat response is obtained.

22 BALANCE CONTROL

This knob is used to adjust the relative volume of the left and right channels, enabling you to compensate for unbalance created by installation locations of the speakers.

23 CONTINUOUS LOUDNESS CONTROL

This control provides compensation for the human ear's loss of sensitivity to high and low frequency ranges at low volumes. As the amount of compensation required is determined by the listening level this control provides the most accurate compensation for any listening level. Set it to the flat position while the volume is set to your normal listening level. Turning it counterclockwise will decrease the volume while retaining the natural balance of low and high frequencies.

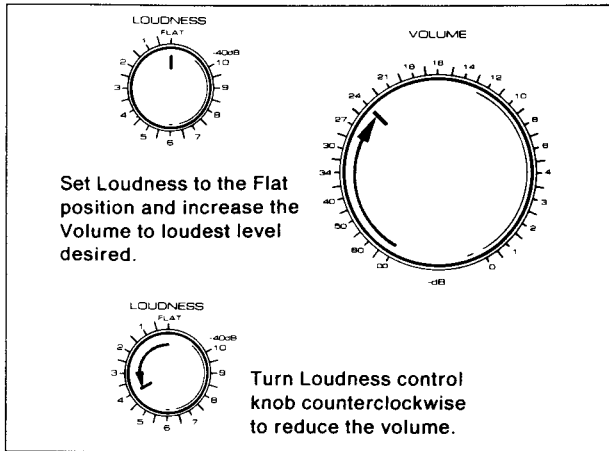

④ REC OUT SELECTOR

This selector allows you to record one source while monitoring another independent source via the Input Selectors. The Rec Out Selector also permits tape copying from Tape 1 to 2 or 2 to 1.

⑤ REMOTE CONTROL WINDOW

Aim the remote control transmitter at this window for remote operation.

REMOTE CONTROL TRANSMITTER

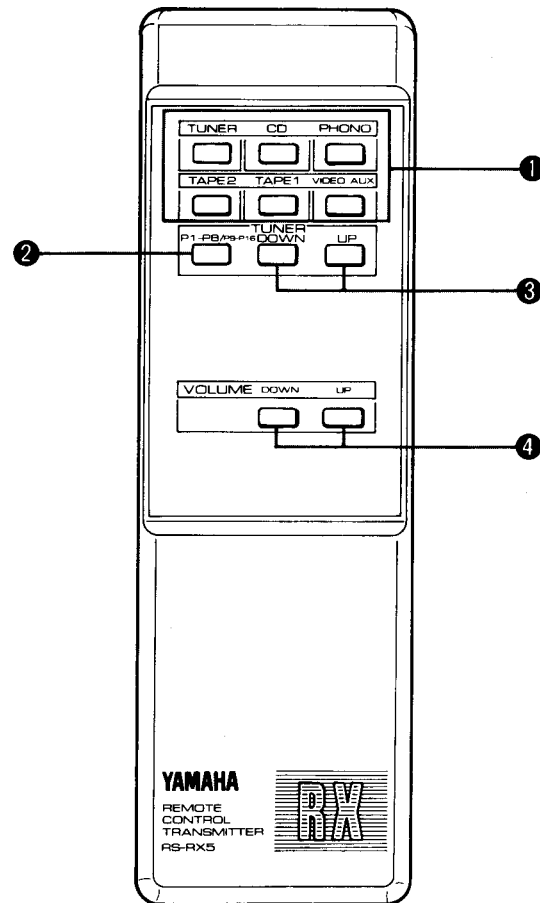

① INPUT SELECTOR BUTTONS

Use to select desired program source.

② P1-P8/P9-P16 SELECTOR BUTTON

Selects the range of the preset station buttons.

③ UP/DOWN BUTTONS

Use to select desired preset station. UP selects a higher numbered preset key, DOWN selects a lower numbered preset key.

④ VOLUME UP/DOWN BUTTONS

Press either button to adjust the volume level.

REMOTE CONTROL WINDOW

Aim the remote control transmitter at this window for remote control operation.

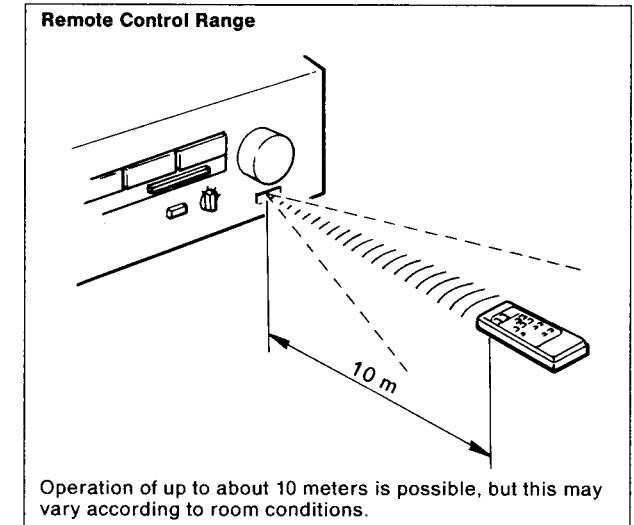

CONNECTIONS

The connection diagram is provided on page 62.

- 1 Turntable
- 2 Compact disc player
- 3 Speaker A
- 4 Speaker B
- 5 Tape deck 2
- 6 Tape deck 1
- 7 Video player

● CONNECTING THE AM ANTENNA

In many cases it will be possible to get excellent AM reception with the supplied AM loop antenna. Attach the antenna leads to the GND and AM ANT terminals and clip the antenna on to its bracket, then rotate the antenna to the best reception position. The loop antenna may also be removed and hung on a wall.

If necessary an outdoor antenna may be used for improved AM reception. Connect a 5 ~ 10 meter length of insulated wire to the AM ANT terminal and run it outdoors.

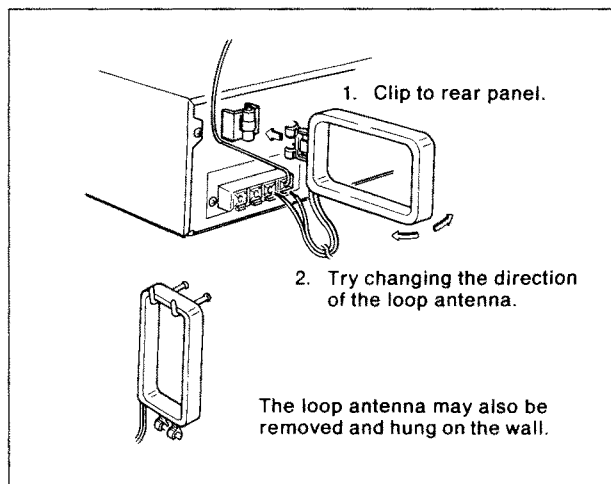

● CONNECTING THE FM ANTENNA

When connecting an FM antenna that is appropriate to local reception conditions, consider the distance from broadcast stations and possible interference from surrounding tall buildings. In cases where there are strong signals from local stations, a portable indoor T-type antenna is usually adequate.

8 Connect the feeder wire to the 300Ω terminal, stretch

the wire out tight and turn to obtain optimum reception. Attach to a suitable support such as a wall. If necessary an outdoor FM antenna may be used for improved FM reception. Either 300Ω flat twin-lead wire or coaxial cable may be used. In locations troubled by electrical interference, coaxial cable is preferable.

Connections for the 300Ω flat twin-lead wire are the same as for the Indoor T-type antenna. For the coaxial cable, connect the center conductor to the left 75Ω terminal and the braid cable to the right 75Ω terminal.

NOTE: Connect either an outdoor FM antenna or an indoor FM T-type antenna but not both.

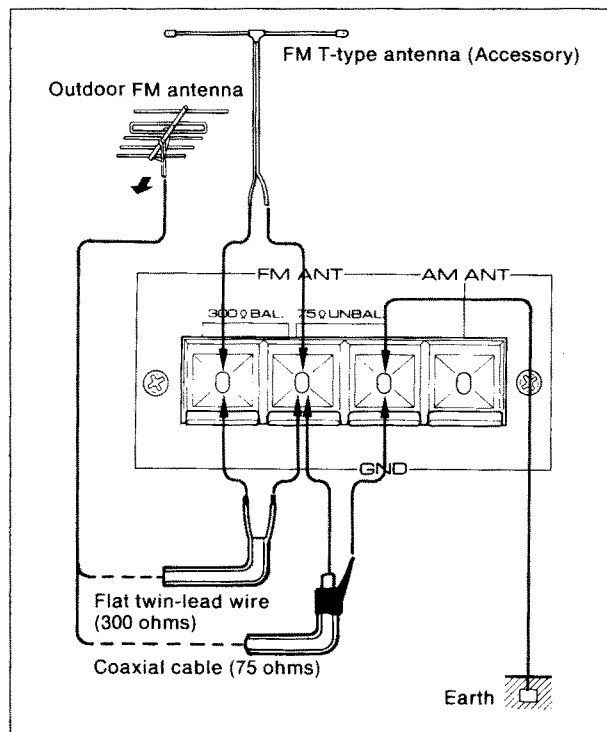

FOR EUROPEAN MODEL

The T-type antenna connection is made using the supplied 300Ω/75Ω adapter plug. Loosen the screws of the supplied plug, insert the ends of the feeder wires between the screws and the underlying metal plates, then tighten the screws.

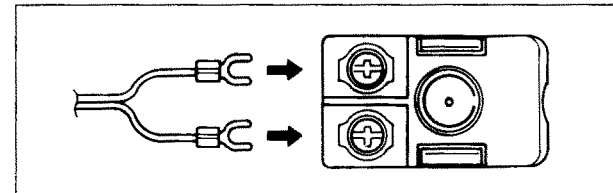

For the outdoor FM antenna, connection is made using the supplied 75Ω/300Ω adapter plug.

For 300Ω flat twin-lead wire follow the procedure outlined for the T-type antenna.

For coaxial cable, prepare the cable as shown below.

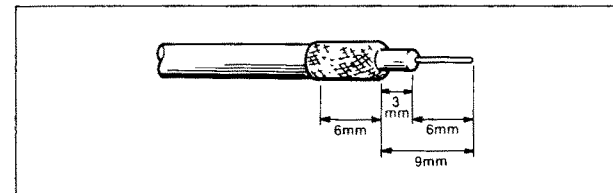

Connect the processed coaxial cable to the 300Ω/75Ω adapter as shown below. The collar indicated in the diagram below must be removed and attached to the pole on the inside of the adapter cover. (See note inside adapter cover.)

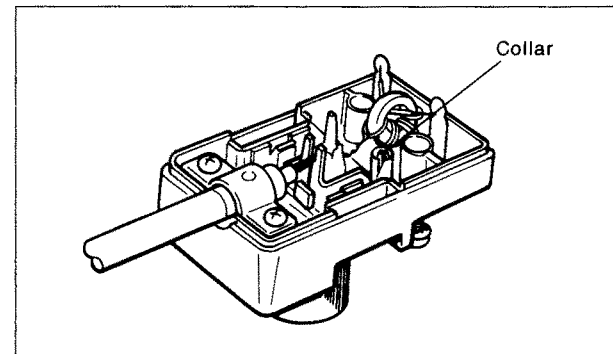

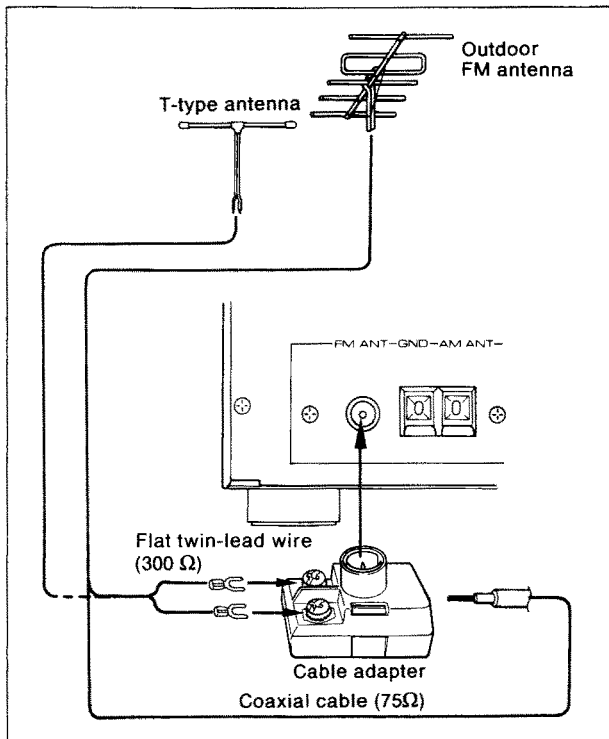

● CONNECTING THE SPEAKERS

Connect the cords for the left speakers to the L terminals and connect the right speaker cords to the R terminals. Ensure that the polarity (+ and -) markings are observed. Be sure to do this consistently between components. If the polarity is reversed at either speaker the sound will be unnatural and lack bass. Speaker cords should be cut as short as possible. Avoid coiling the wire on the floor or bundling it up with cords from other system components.

Strip about 10mm (0.39in) of insulating material from the ends of the speaker wires and twist the exposed strands of each end. Push in on the terminal lever, insert the exposed wire and then pull the lever forward to lock the wire into position.

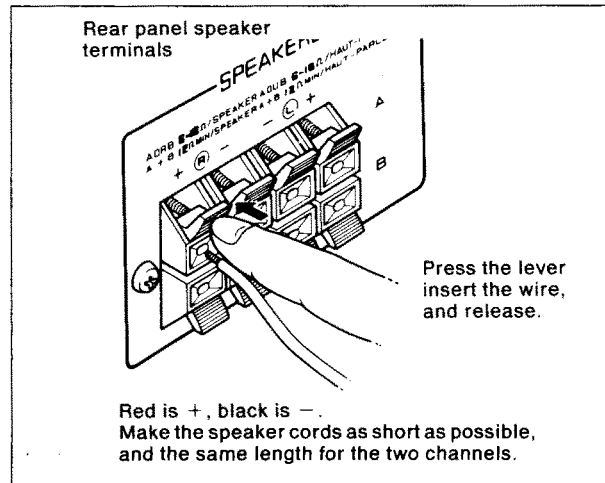

● CONNECTING A TURNTABLE

Connect the output cords of the turntable to the PHONO jacks and connect the ground wire to the GND terminal. Normally connecting the ground wire produces minimum hum but in some cases better results are obtained with the ground wire disconnected. The turntable component and its output cords should be positioned well away from sources of hum such as power cords or power transformers of other system components.

● CONNECTING A TAPE DECK TAPE DECK 1.

Connect the cords from the tape deck's Line In jacks to the REC OUT jacks of TAPE 1, ensuring that the left and right are not reversed. Then connect the cords from the tape deck's Line Out jacks to the Tape 1 PB jacks.

TAPE DECK 2 can be connected to the Tape 2 terminals in similar fashion.

● CONNECTING TO THE CD AND VIDEO/AUX JACKS

Connect your CD component to the CD terminals and video sound output leads to the VIDEO/AUX terminals. Please note that a turntable can not be connected to these jacks as they do not provide the necessary RIAA equalization.

● AC OUTLETS (General and Canadian models)

For added convenience the RX-500/U provides 2 AC outlets. One "switched" outlet (the power to this outlet is controlled by this unit's power switch) and one "unswitched" outlet (the power to this is independent of this unit's power switch). Be sure not to connect appliances totaling more than 200 watts to the unswitched outlet or more than 100 watts to the switched outlet.

● GROUNDING

For added safety and reduced interference, grounding is recommended. Be sure not to connect ground wire to a water or gas pipe as this may result in electric shock or fire.

● ABOUT THE FREQUENCY STEP SWITCH (General Model)

Areas other than the United States, Canada and Europe, because interstation frequency spacing is different in different areas, please set rear panel FREQUENCY STEP switch to agree with the station spacing in your area (50 kHz FM/9 kHz AM or 100 kHz FM/10 kHz AM).

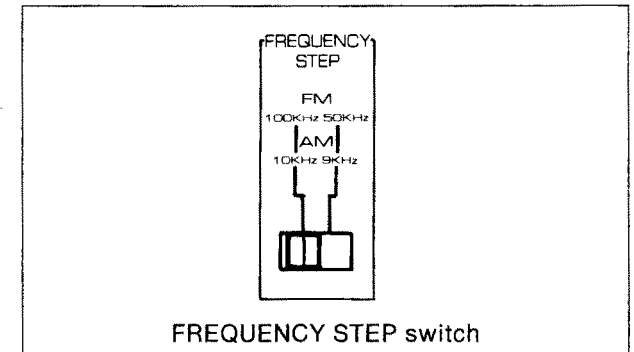

OPERATIONS

● AUTO TUNING

If signals are strong and there is no interference, quick automatic search tuning is possible.

1. Select the reception band with the **BAND SELECTOR**.
2. Press the **TUNING MODE** key to Auto.
3. Use the **TUNING** key to tune.
Automatic tuning will tune in the first broadcast station frequency with sufficient signal strength.
4. If the station where tuning stops is not the one you want, press the **TUNING** key once again.
Auto tuning may not stop if the station signal is weak. If so, use manual tuning.

● MANUAL TUNING

1. Select the reception band with the **BAND SELECTOR**.
2. Press the **TUNING MODE** key to Manual.
3. Use the **TUNING** key to tune.
The frequency will change rapidly if the **TUNING** key is held depressed. Release it slightly before reaching the desired frequency, and then press it intermittently until the desired frequency is reached.

● PRESET TUNING

This unit can store a total of 16 stations in memory. The stations can be any combination of AM and FM broadcasts. To preset a station into the memory first tune in the desired station. Press the Memory Key and while the Memory Indicator is lit depress one of the numbered Preset Keys to store the displayed frequency into the memory. The band is automatically memorized with the frequency. Placing another frequency in the same memory channel automatically cancels the station previously stored in that channel.

To ensure proper programming of preset stations, the receiver should remain on for at least one hour when first setting the preset frequencies.

● LISTENING TO FM BROADCASTS

1. Set the Input Selector to Tuner.
2. Press the Band Selector to FM.
3. Tune in the desired station by following one of the tuning methods described above.
4. When the reception is in stereo the ST Indicator will light, however, for very weak stereo signals and mono stations, it remains off.
5. Adjust your Volume, Loudness, Bass, Treble and Balance controls to provide the desired sound quality.

● LISTENING TO AM BROADCASTS

1. Set the Input Selector to Tuner.
2. Set the Band Selector to AM.
3. Tune in the desired station by following one of the tuning methods described above.
4. Adjust your Volume, Loudness, Bass, Treble and Balance controls to provide the desired sound quality.

● PLAYING BACK CDs, AUX/VIDEO, RECORDS, OR TAPES

1. Set the Input Selector to the desired input.
2. Activate the source component.
3. Adjust your Volume, Loudness, Bass, Treble and Balance controls to provide the desired sound quality.

● RECORDING TAPES

1. Use the Rec Out Selector to select the source to be recorded.
2. Activate the source component, then turn the volume up to confirm the Input Source.
3. Set the tape deck to RECORD.
If your tape deck has three head monitoring capability, the just recorded signal can be monitored. Press the receiving Tape deck button (Tape 1 or Tape 2) to monitor the recording through the speakers or headphones.
4. Adjusting Volume, Loudness, Bass, Treble and Balance controls during recording has no effect on the material being recorded.

● TAPE DUBBING

Tape dubbing can be performed from either Tape 1 to 2 or 2 to 1.

1. Set the Rec Out Selector to the copy 1-2 or 2-1 position.
2. Set the source deck to play and the receiving deck to record.
3. To monitor the source sound simply press the corresponding Input Selector key. If your tape deck has three head monitoring capability you can monitor the just recorded signal by using the Input Selector to select the receiving deck.

To listen to an alternate sound source merely press the desired Input Selector key. This has no adverse effects on the dubbing quality.

MULTIPATH INTERFERENCE

Multipath is an effect similar to television ghosting; it distorts the received signal and also causes poor stereo separation and noise. As shown below, radio waves which travel directly from the transmitter to the receiving antenna are mixed with waves which reflect off nearby objects such as buildings. Because the path taken by the reflected waves is longer than the direct path, the time required for the waves to arrive at the antenna is also longer. The mixing of the directly received signal and the delayed signal noticeably degrades reception quality. Multipath interference can be greatly reduced by the use of a high-quality directional antenna correctly oriented.

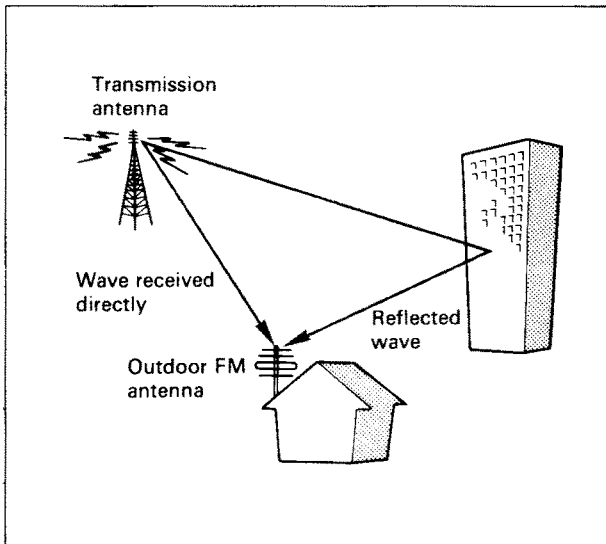

PREVIOUS-STATION MEMORY

- If power is turned off while a station is tuned in, the same station will be tuned in automatically when power is turned on again. Even if the power cord is pulled out rather than the power key being turned off, the effect is the same.
- When the reception band is changed from FM to AM, the last AM station listened to will automatically be tuned in again. In the same way, when reception band is changed from AM to FM, the last FM station will be tuned in again.
- * If the power is turned off or the Band selector is pressed while auto-search tuning is in progress, next time the power is turned on or the Band selector is pressed no station may be tuned in even though the frequency display is lit.

General Model

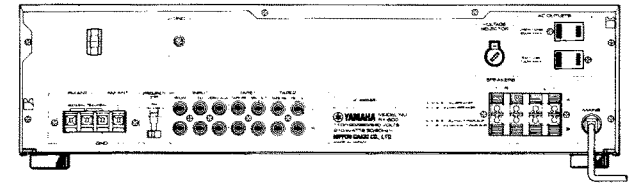

British and Australian Model

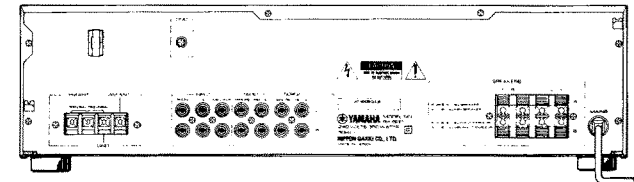

European Model

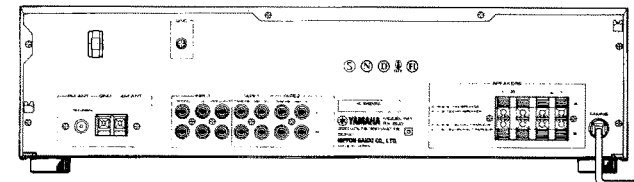

TROUBLESHOOTING

Before assuming that your unit is faulty, please check the following troubleshooting list which details the corrective action you can take yourself without having to call a service engineer. If you have any doubts or questions, contact your nearest Yamaha dealer.

	FAULT	CAUSE	REMEDY
AUDIO	Power is not supplied even though the POWER switch is turned on .	The power cord is not plugged in.	Plug in the power cord.
	There is no sound even when the Input Selector is pressed.	The speaker connections are not secure.	Set them correctly.
		The input cords are not connected securely.	Plug them in securely.
	There is no sound from one speaker.	The speaker connections are not secure.	Secure the connections.
		The BALANCE control is set all the way to the left or right.	Adjust the BALANCE control correctly.
	There is a lack of bass and no ambience.	The + and - cords have been reversed at the receiver or the speakers.	Connect the speaker cords in the correct phase (+ and -).
	There is a humming sound when playing records.	The input cords are not connected securely.	Plug the input cords in securely.
The turntable's ground wire is not connected.		Connect the ground wire.	
There is a howling sound when playing records at high volume.	The turntable and the speakers are too close together or the turntable is not mounted on a firm surface.	Change the location of the turntable or the speakers.	
FM	Crackling sounds from time to time (especially in weak signal areas).	Ignition noise from vehicles.	The FM antenna should be put up as high as possible, away from the road, and a coaxial cable used.
		Noise from thermostats and other electrical equipment.	Attach a noise suppressor to the equipment causing the noise.
	FM stereo reception is noisy.	The transmitter is far away or the antenna input is poor.	Check the antenna connections.
			Try using a multiple element FM antenna.
	The ST indicator flickers on and off and reception is noisy.	Insufficient antenna input.	Use an antenna appropriate for the reception conditions in your area.
		Not tuned correctly.	Tune again.
	There is distortion and clear reception cannot be obtained even with a good FM antenna.	There is multipath interference.	Adjust antenna placement to eliminate multipath interference.
No stereo effect even with a stereo broadcast.	The TUNING MODE selector is set to MAN'L FM MONO.	Set the selector properly.	

	FAULT	CAUSE	REMEDY
FM	A desired station cannot be tuned in with Auto Tuning.	The station is too weak.	Reorient your antenna or try using a high-quality directional antenna.
	Previously preset stations can no longer be tuned in.	The receiver has been unplugged for a long period.	Repeat the preset procedure.
		When setting presets the unit must remain on for at least one hour for preset frequencies to be properly memorized.	When setting presets leave unit on for approx. one hour.
AM	Insufficient sensitivity in AM broadcasts.	Weak signal or loose antenna connections.	Tighten the AM loop antenna connections and rotate it for best reception.
			Use an outdoor antenna.
	There are continuous crackling and hissing noises.	These noises result from lightning, fluorescent lamps, motors, thermostats and other electrical equipment.	Use an outdoor antenna and a ground wire.
	There are buzzing and whining noises.	A TV set is being used nearby.	Move the TV set a distance away.

SPECIFICATIONS

● AUDIO SECTION

Minimum RMS Output Power Per Channel	
20Hz ~ 20kHz 0.015% THD 8Ω	48W
0.05% THD 6Ω	53W
Dynamic Power Per Channel	
(by IHF Dynamic Headroom measuring method)	
8Ω/6Ω/4Ω	75W/90W/100W
DIN Standard Output Power Per Channel	
1kHz 1% THD 4Ω	65W
IEC Power	
1 kHz 0.01% THD 8Ω/6Ω	57W/67W
Power Bandwidth	
0.1% THD 25W 8Ω	10Hz ~ 50kHz
Damping Factor	
1kHz 8Ω	> 50
Maximum Input Signal 1kHz	
0.01% THD Phono MM	120mV
Output Level/Impedance	
REC OUT	150mV/1.5kΩ
Headphone Jack Rated Output/Impedance	
0.015% THD RL = 8Ω	0.7V/220Ω
Frequency Response	
20Hz ~ 20kHz CD/VIDEO·AUX/TUNER/TAPE	0 ± 0.5dB
RIAA Equalization Deviation	
MM	± 0.5 dB
Total Harmonic Distortion 20Hz ~ 20kHz	
Phono MM 3V	0.01%
CD/VIDEO·AUX/TUNER/TAPE to Sp Out 25W/8Ω	0.015%
Intermodulation Distortion	
CD/VIDEO·AUX/TUNER/TAPE Rated Output/8Ω	0.01%
Signal to Noise Ratio (IHF-A-Network)	
Phono MM (5mV Input Shorted)	82dB
CD/VIDEO·AUX/TUNER/TAPE (Shorted)	103dB
Channel Separation Vol - 30dB	
Phono MC·MM Input Shorted 1kHz	55dB
CD/VIDEO·AUX/TUNER/TAPE	
Input 5.1kΩ terminated 1kHz	52dB
Tone Control Characteristics	
BASS boost/cut	± 10dB at 50Hz
turnover frequency	350Hz
TREBLE boost/cut	± 10dB at 20kHz
turnover frequency	3.5kHz

Filter Characteristics

Bass Extension	60Hz 8dB/oct
Continuous Loudness Control (Level Related Equalization)	
Attenuation	- 40dB (1kHz)
Output Level/Impedance (Fixed)	
FM 30% MOD 1kHz	400mV/6.8kΩ
AM 30% MOD 1kHz	150mV/6.8kΩ
Harmonic Distortion	
1kHz	0.2%
Stereo Separation	
1kHz	50dB
Frequency Response	
30Hz to 15kHz	0 ± 0.5dB
Alternate Channel Selectivity	
	85dB
Selectivity (two signals) (European model)	
40kHz Dev	50dB
Signal to Noise Ratio (IHF)	
mono	81dB
stereo	76 dB
Signal to Noise Ratio (DIN-Unweighted) (European model)	
mono	76dB
stereo	70dB
Harmonic Distortion	
mono 1kHz	0.1%

● FM SECTION

Tuning Range

Canadian and General models	87.5 ~ 107.9MHz
European, General, Australian and British models	87.5 ~ 108.0MHz

50dB Quieting Sensitivity (IHF)

75Ω mono	1.55μV (15.1dBf)
stereo	21μV (37.7dBf)

Usable Sensitivity

75Ω 1kHz 100% MOD	0.8μV (9.3dBf)
	(30 dB S/N Quieting)

Usable Sensitivity (DIN)

75Ω mono (S/N 26dB)	1.4μV
stereo (S/N 46dB)	30.0μV

Image Response Ratio

.....	50dB
-------	------

(European model) 90dB

IF Response Ratio

.....	75dB
-------	------

(European model) 85dB

Spurious Response Ratio

.....	70dB
-------	------

AM Suppression Ratio

.....	55dB
-------	------

Capture Ratio

.....	1.5dB
-------	-------

● **AM SECTION**

Tuning Range

Canadian and General models 530 ~ 1610kHz
European, General, Australian and British models 531 ~ 1611kHz

Usable Sensitivity 250µV/m

Selectivity 32dB

Signal to Noise Ratio 50dB

Image Response Ratio 40dB

Spurious Response Ratio 50dB

Harmonic Distortion 0.3%

● **GENERAL SECTION**

Power Supply

European model AC 220V 50Hz
Australian & British model AC 240V 50Hz
General model AC 110/120/220/240V 60/50Hz

Power Consumption

European model 350W
Australian & British model 350W
General model 210W

AC Outlet (General model)

Switched x 1 100W max.
Unswitched x 1 200W max.

Dimensions (W x H x D) 435 x 126 x 289mm
(17.1 x 5.0 x 11.4 in)

Weight 5.6kg
(12.3lbs.)

* *Specifications subject to change without notice.*

CONNECTION DIAGRAM

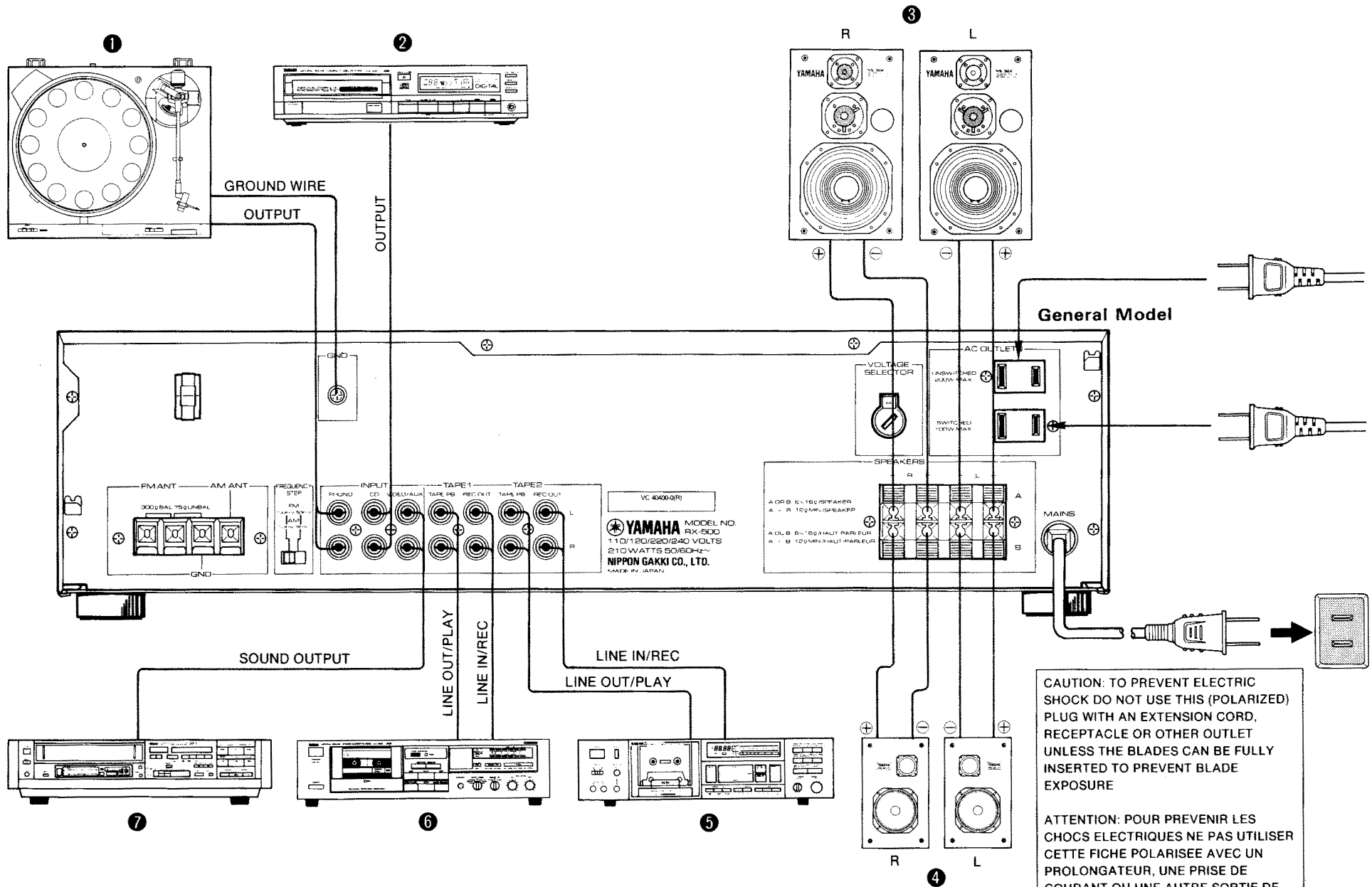

CAUTION: TO PREVENT ELECTRIC SHOCK DO NOT USE THIS (POLARIZED) PLUG WITH AN EXTENSION CORD, RECEPTACLE OR OTHER OUTLET UNLESS THE BLADES CAN BE FULLY INSERTED TO PREVENT BLADE EXPOSURE

ATTENTION: POUR PREVENIR LES CHOCS ELECTRIQUES NE PAS UTILISER CETTE FICHE POLARISEE AVEC UN PROLONGATEUR, UNE PRISE DE COURANT OU UNE AUTRE SORTIE DE COURANT, SAUF SI LES LAMES PEUVENT ETRE INSEREES A FOND SANS EN LAISSER AUCUNE PARTIE A DECOUVERT

